

FIKA 6.5L SLOW COOKER

Product Instructions

Product No. 2013340.1

VonShef

Let's get started!

Visit our product hub for useful tips and tricks on getting the most out of your new product.

SCAN ME



Parts & Components

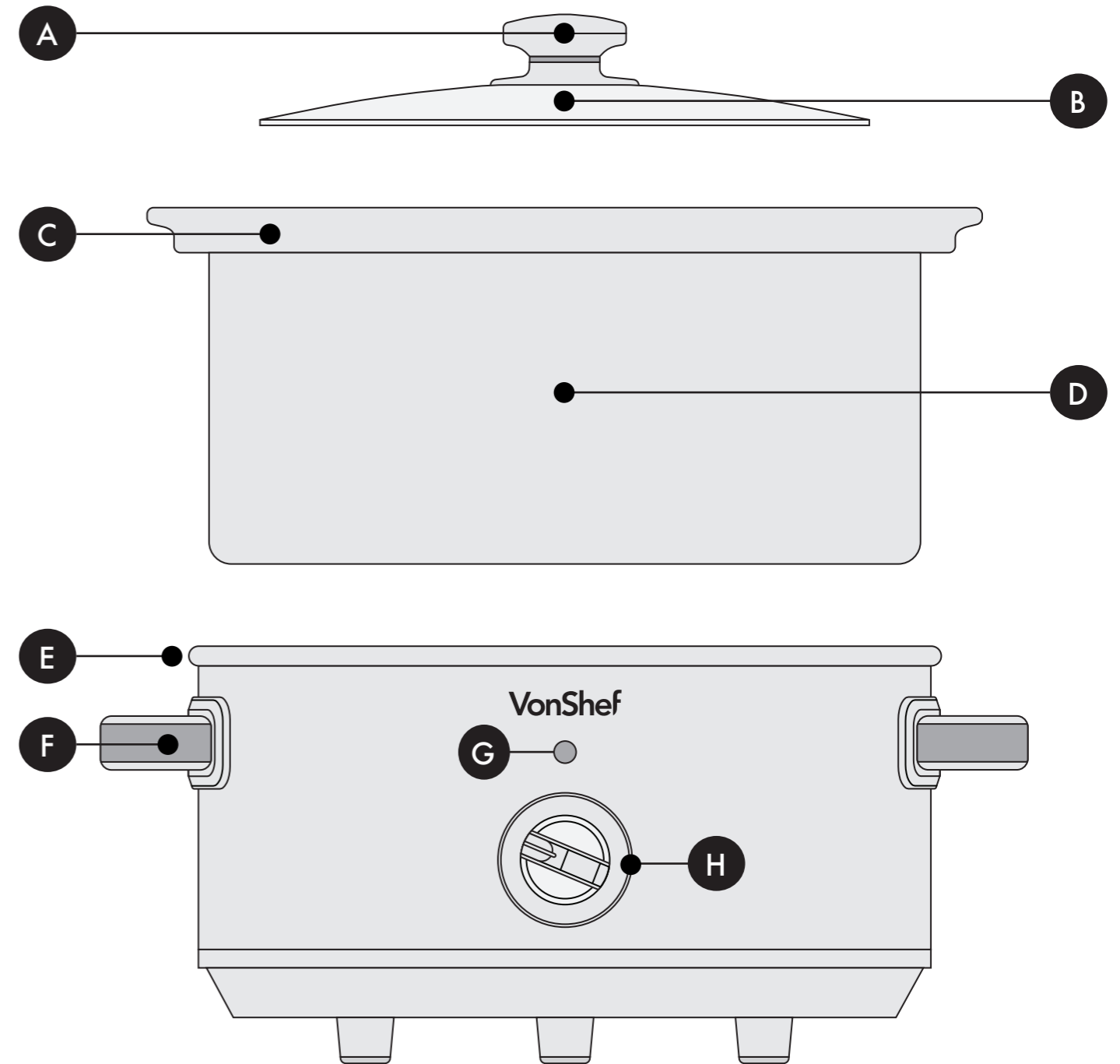

Need further help?
support@vonhaus.com

See our full range at
www.vonhaus.com

- A. Handle
- B. Glass Lid
- C. Ceramic Bowl Handles
- D. Ceramic Bowl
- E. Base Unit
- F. Unit Handles
- G. Power Indicator
- H. Temperature Control Dial

Before First Use & Maintenance

Wipe with a damp cloth

CAUTION: Do not immerse in water.

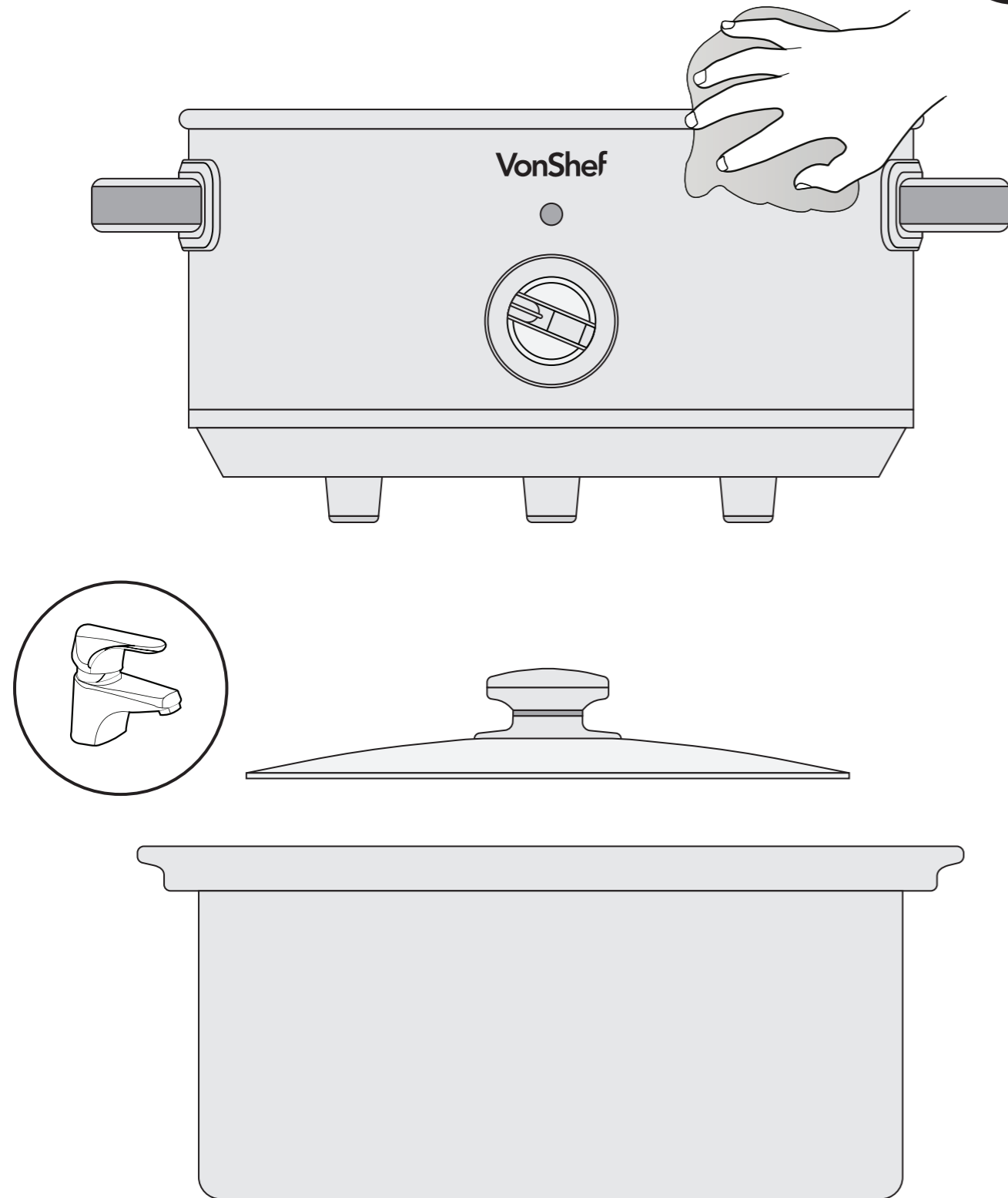

Operation

1

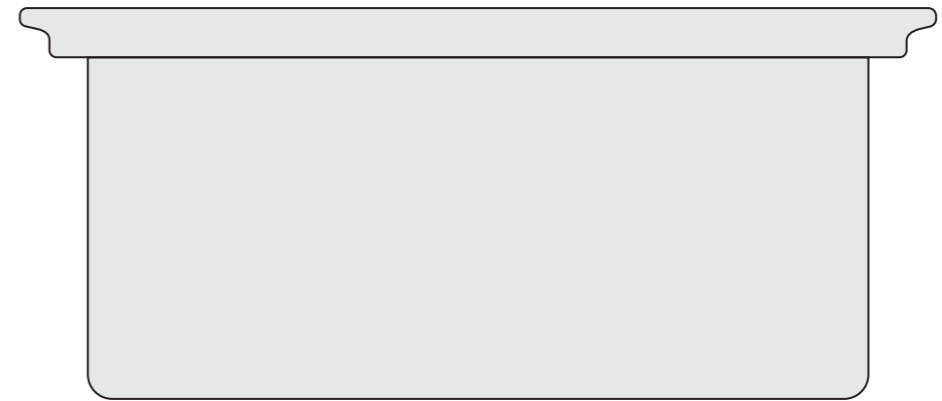
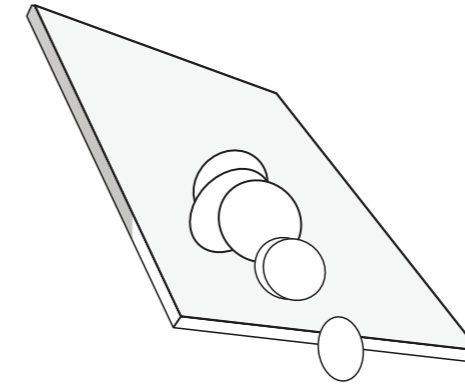

2

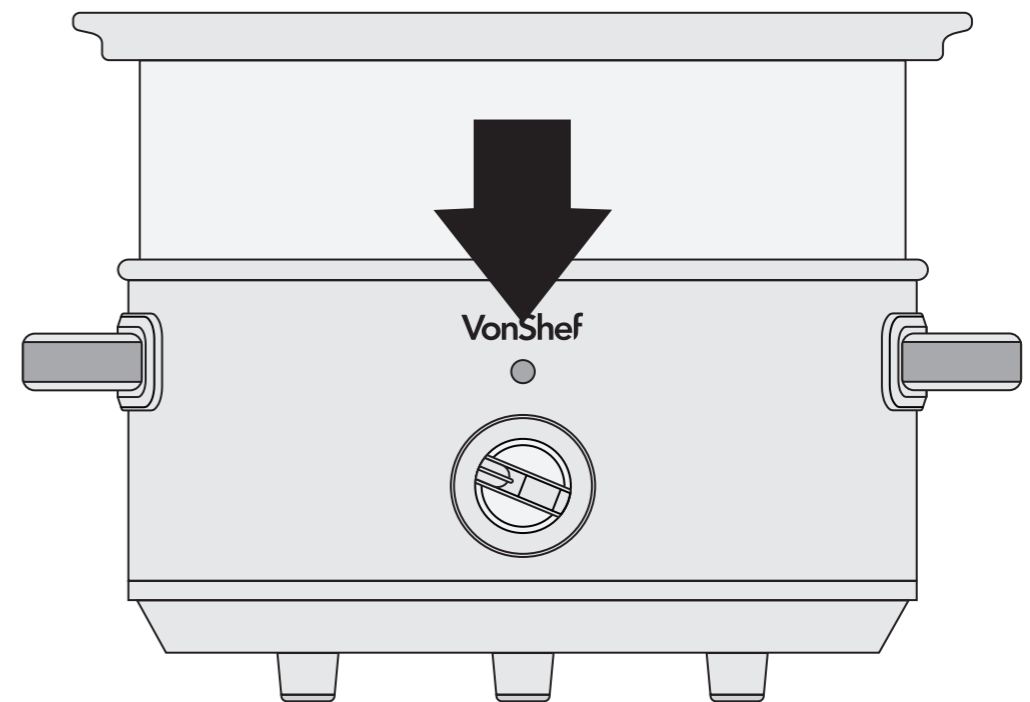

Operation

3

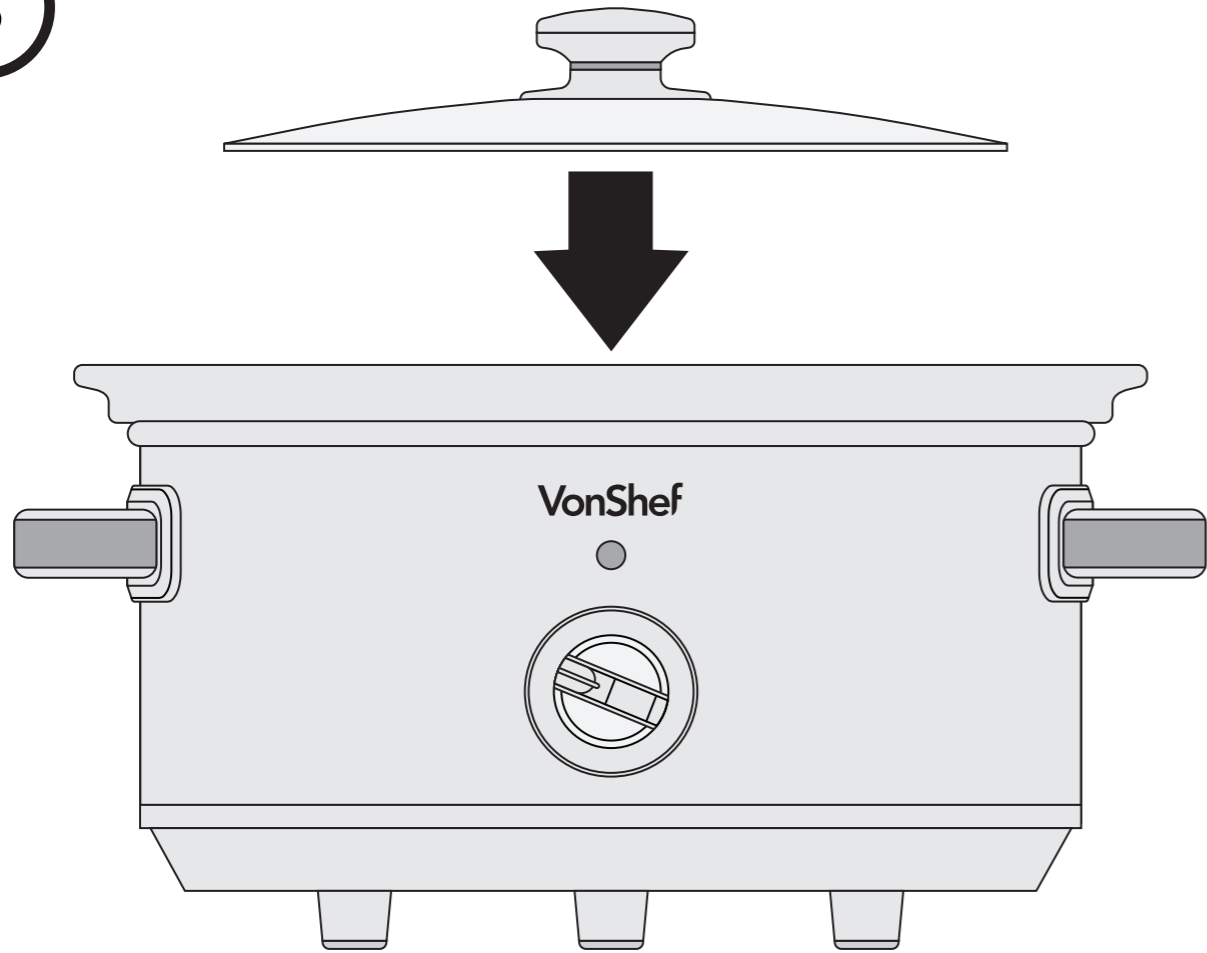

4

Low - 6-8 Hours
High - 3-5 Hours

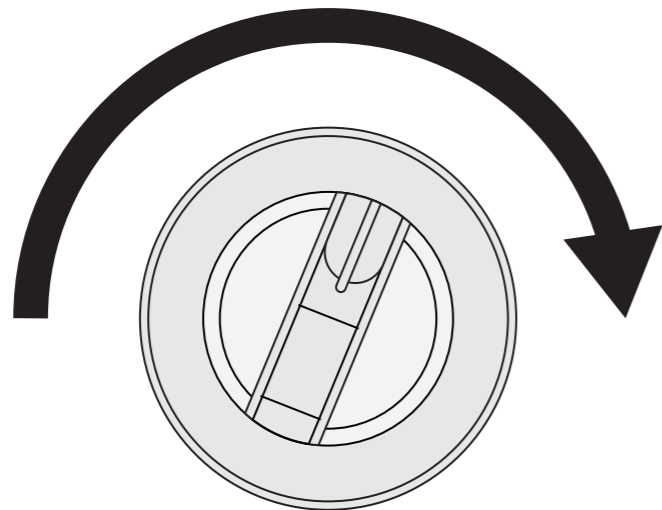

Operation

5

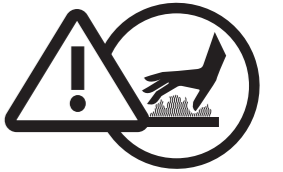
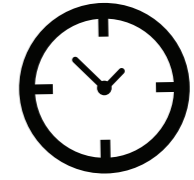

1-10 Hours

6

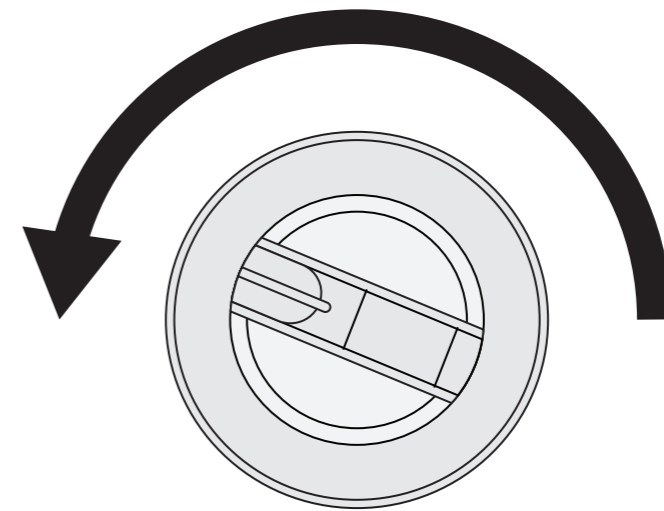
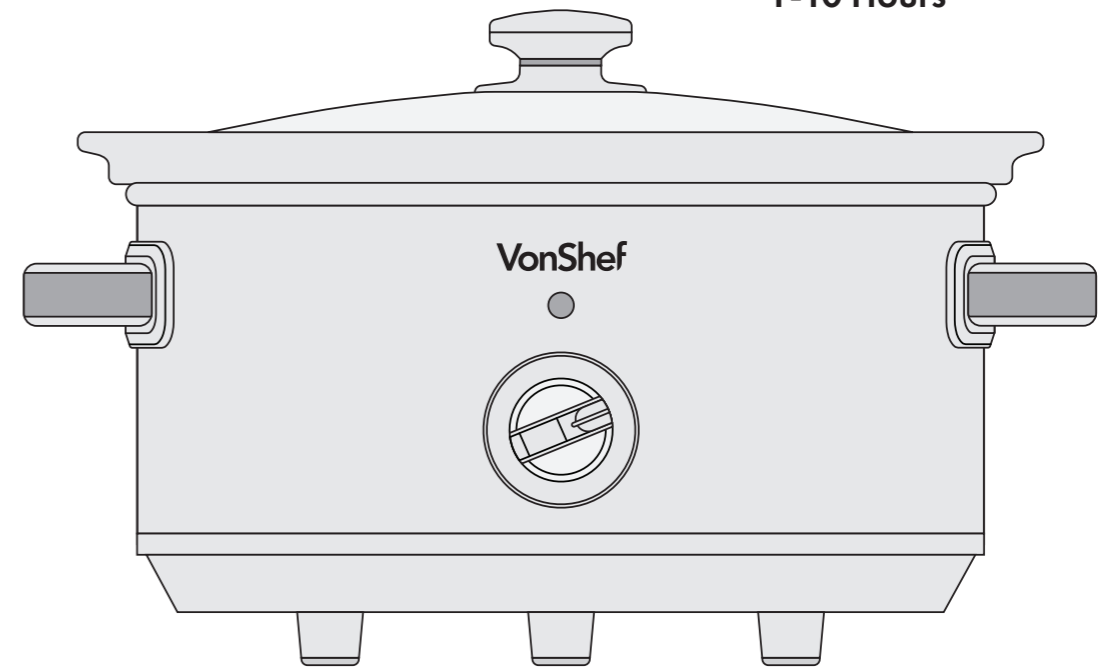

Operation

7

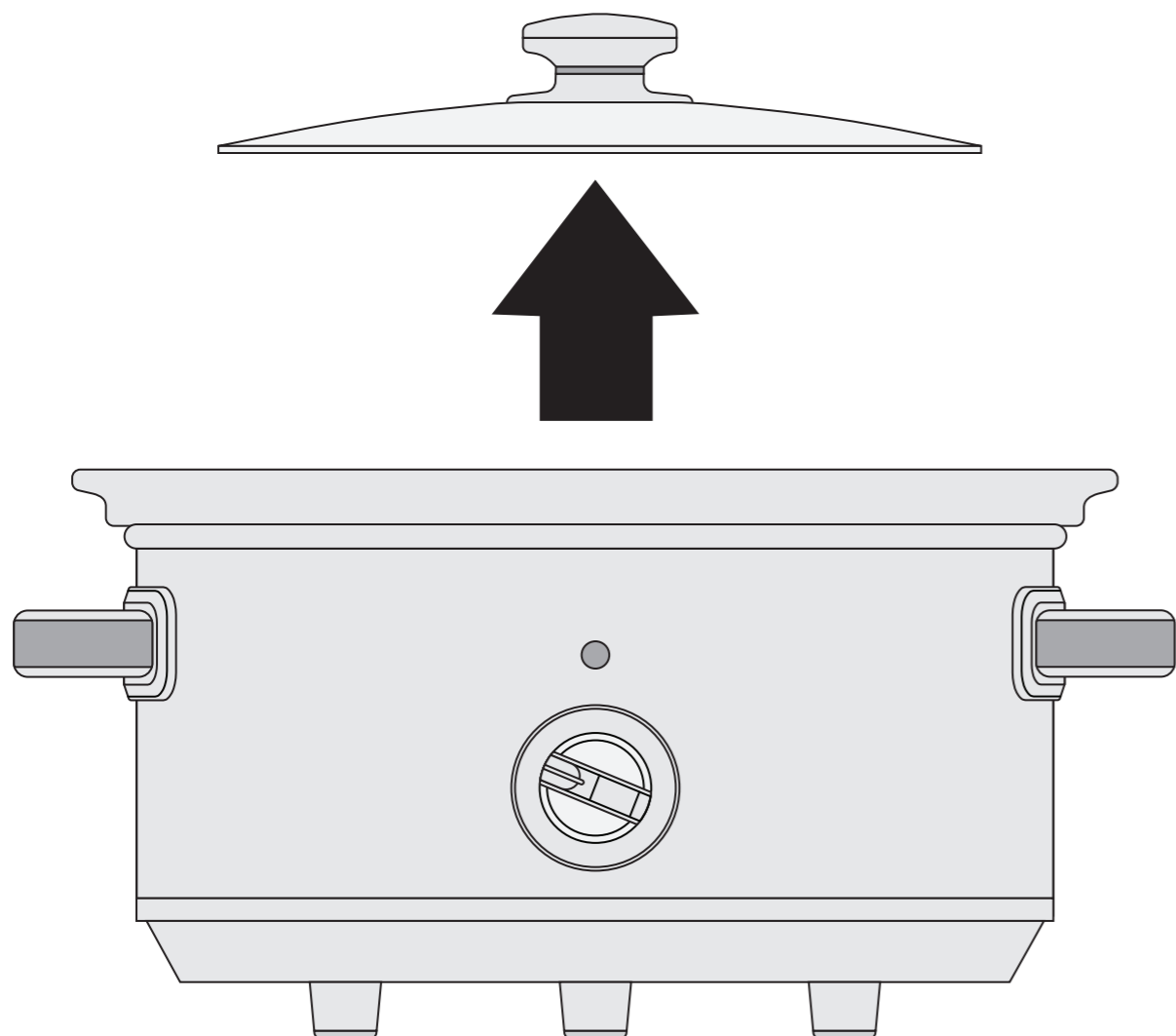

Information

Operation

Always place the appliance on a flat, stable surface with space around all sides, and ensure the area is fully ventilated.

The appliance must be at least half full for best results. When cooking soups, leave at least 5 cm of space from the top of the ceramic bowl. Smaller pieces of ingredients will cook faster.

Do not use frozen meat or poultry unless fully thawed first. Always use wooden or silicone utensils to add or remove food from the base unit. Do not overload. All ingredients must be pre-prepared—do not attempt to slice them inside the appliance.

Always fit the glass lid correctly during use. Do not operate without the lid. The lid may be removed to stir food, but avoid removing it unnecessarily as heat will escape. Take care when lifting the lid, as excess steam may cause scalding.

Temperatures can be adjusted at any time during operation. Avoid touching any part of the appliance once in operation; surfaces get very hot, and oven mitts are recommended.

Once cooking is complete, switch off by turning the dial to "OFF" and unplug the power cord. To keep food warm, turn the dial to "WARM".

Allow the appliance to cool fully before removing the ceramic bowl. Clean the ceramic bowl thoroughly before the next use.

Important Safety Notice

This product is not suitable for use by children or by individuals with physical, sensory, or mental impairments that may limit their ability to operate the equipment safely, unless they have been given supervision or instruction concerning the safe use of the product by a person responsible for their safety.

Improper use may result in serious injury. Always ensure the operator is capable of understanding and following all safety instructions provided in this manual.

General Safety

Do not allow the appliance to be used as a toy. Children must be supervised to ensure they do not play with it.

If the appliance stops working properly, has been dropped, damaged, left outdoors, or immersed in liquid, do not use—contact DOMU Brands Customer Services.

Do not use if any part is faulty, missing, or damaged. Ensure all parts are securely attached before use.

Cables and Plugs

Check your power supply matches the rating plate. Only use as rated. Preferably connect to an outlet protected by an RCD (UK/EU) or Ground Fault Indicator (US).

Do not use with a damaged cable or plug. If damaged, the supply cable must be replaced by a qualified engineer or authorised service agent. Do not use extension cables.

Do not handle the plug or appliance with wet hands. Keep cables away from hot surfaces.

Information

Do not let the cable hang over table or counter edges where it could be pulled by children or pets.

Do not pull cables around sharp edges or corners.

Do not leave the appliance unattended when plugged in. Unplug when not in use.

Turn off all controls before unplugging, and grasp the plug—never the cable.

Unplug before maintenance, attaching/detaching parts, or changing accessories.

Store the cable safely to avoid hazards.

Risk of Personal Injury

Place the appliance on a firm, flat, heat-resistant surface with space on all sides, away from edges.

Do not insert objects into openings or cover the appliance.

Do not place cardboard, plastics, or paper inside/on it unless the instructions specify.

Do not use near combustible surfaces. Only use suitable cookware where applicable.

Do not use outdoors or near heat sources.

Avoid touching hot surfaces during and after use.

Never operate when empty.

Do not overload or overfill.

On first use, the appliance may emit a temporary smell or vapor.

Do not lift or move while operating.

Do not run continuously longer than times marked on the product or in this manual.

Switch off and unplug before changing accessories or cleaning.

Use only as described and with DOMU Brands recommended attachments.

Cleaning and Maintenance

Never soak or immerse electrical or heating components, or parts with a plug.

Hand wash only—soak in warm soapy water and wipe with a soft sponge. For stubborn stains, use a non-abrasive brush.

Do not use abrasive cleaners, harsh solutions, or metal scouring pads.

Do not wash electrical or heating components, or plug-connected parts, in a dishwasher.

Technical Specification

Rated Voltage: 220–240V

Rated Power: 290W

Rated Frequency: 50/60Hz

Usage & Safety



Please read all instructions carefully before use and retain for future reference.



CAUTION: Hot surfaces



Do not immerse in water.

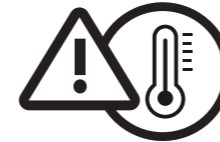

ATTENTION This appliance has a thermal cut out switch. The thermal cut out will activate and shut down the appliance should the appliance overheat. Unplug from the mains and or battery and allow to cool for 30 minutes before re-use.

Information

Customer Service

If you are having difficulty using this product and require support, please contact support@vonhaus.com

Warranty

To register your product and find out if you qualify for a free extended warranty please go to www.vonhaus.com/warranty

Please retain a proof of purchase receipt or statement as proof of the purchase date.

The warranty only applies if the product is used solely in the manner indicated in the warnings page of this manual, and all other instructions have been followed accurately.

Any abuse of the product or the manner in which it is used will invalidate the warranty.

Returns

Returned goods will not be accepted unless re-packaged in its original packaging and accompanied by a relevant and completed returns form. This does not affect your statutory rights.

No rights are given under this warranty to a person acquiring the appliance second-hand or for commercial or communal use.

Copyright

All material in this instruction manual are copyrighted by DOMU Brands.

Any unauthorised use may violate worldwide copyright, trademark, and other laws.

Thank You

Thank you for purchasing your product/appliance.

Should you require assistance with your purchase, please contact us at support@vonhaus.com

VonHaus is a registered trademark of DOMU Brands Ltd.

Made in China for DOMU Brands Ltd.
Unit 30, Stakehill Industrial Estate
Middleton, Manchester, M24 2RW

EU Authorised Representative

Authorised Representative Service
77 Camden Street Lower
Dublin, D02 XE80
Ireland

Let's get started!

Visit our product hub for useful tips and tricks on getting the most out of your new product.

SCAN ME

